

# SK 25 GAD 063 T

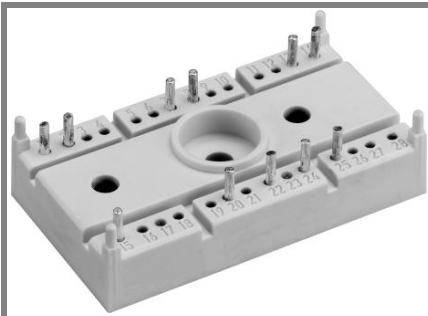

**SEMITOP® 3**

## IGBT Module

### SK 25 GAD 063 T

#### Target Data

#### Features

- Compact design
- One screw mounting
- Heat transfer and isolation through direct copper bonded aluminium oxide ceramic (DCB)
- N-channel homogeneous silicon structure (NPT-Non punch-through IGBT)
- High short circuit capability
- Low tail current with low temperature dependence
- UL recognized, file no. E 63 532

#### Typical Applications

- Switching (not for linear use)
- Inverter
- Switched mode power supplies
- UPS

Absolute Maximum Ratings		$T_s = 25\text{ °C}$ , unless otherwise specified	
Symbol	Conditions	Values	Units
<b>IGBT</b>			
$V_{CES}$		600	V
$V_{GES}$		$\pm 20$	V
$I_C$	$T_s = 25\text{ (80) °C}$ ;	30 (21)	A
$I_{CM}$	$t_p < 1\text{ ms}$ ; $T_s = 25\text{ (80) °C}$ ;	60 (42)	A
$T_j$		- 40 ... + 150	°C
<b>Inverse / Freewheeling CAL diode</b>			
$I_F = -I_C$	$T_s = 25\text{ (80) °C}$ ;	36 (24)	A
$I_{FM} = -I_{CM}$	$t_p < 1\text{ ms}$ ; $T_s = 25\text{ (80) °C}$ ;	72 (48)	A
$T_j$		- 40 ... + 150	°C
$T_{stg}$		- 40 ... + 125	°C
$T_{sol}$	Terminals, 10 s	260	°C
$V_{isol}$	AC 50 Hz, r.m.s. 1 min. / 1 s	2500 / 3000	V

Characteristics		$T_s = 25\text{ °C}$ , unless otherwise specified			
Symbol	Conditions	min.	typ.	max.	Units
<b>IGBT</b>					
$V_{CE(sat)}$	$I_C = 20\text{ A}$ , $T_j = 25\text{ (125) °C}$		1,8 (1,9)	2,2 (2,4)	V
$V_{GE(th)}$	$V_{CE} = V_{GE}$ ; $I_C = 0,0007\text{ A}$	4,5	5,5	6,5	V
$C_{res}$	$V_{CE} = 25\text{ V}$ ; $V_{GE} = 0\text{ V}$ ; 1 MHz		1,6		nF
$R_{th(j-s)}$	per IGBT per module			1,4	K/W K/W
$t_{d(on)}$	under following conditions: $V_{CC} = 300\text{ V}$ , $V_{GE} = \pm 15\text{ V}$		40		ns
$t_r$	$I_C = 25\text{ A}$ , $T_j = 125\text{ °C}$		50		ns
$t_{d(off)}$	$R_{Gon} = R_{Goff} = 33\ \Omega$		200		ns
$t_f$			25		ns
$E_{on} + E_{off}$	Inductive load		2,2		mJ
<b>Inverse / Freewheeling CAL diode</b>					
$V_F = V_{EC}$	$I_F = 25\text{ A}$ ; $T_j = 25\text{ (125) °C}$		1,45 (1,4)	1,7 (1,75)	V
$V_{(TO)}$	$T_j = (125)\text{ °C}$		(0,85)	(0,9)	V
$r_T$	$T_j = (125)\text{ °C}$		(22)	(32)	mΩ
$R_{th(j-s)}$				1,7	K/W
$I_{RRM}$	under following conditions: $I_F = 25\text{ A}$ ; $V_R = 300\text{ V}$		16		A
$Q_{rr}$	$di_F/dt = -500\text{ A}/\mu\text{s}$		2		μC
$E_{off}$	$V_{GE} = 0\text{ V}$ ; $T_j = 125\text{ °C}$		0,25		mJ
<b>Mechanical data</b>					
M1	mounting torque			2,5	Nm
w			30		g
Case	SEMITOP® 3		T 57		

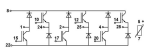

**GAD**

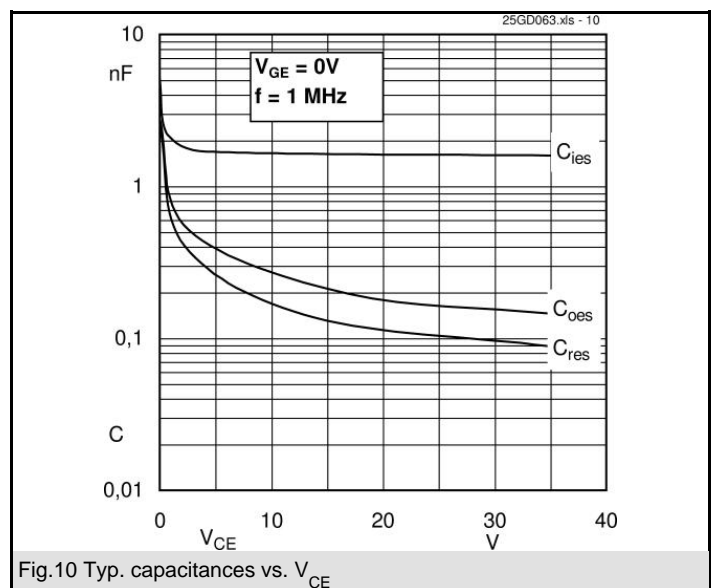
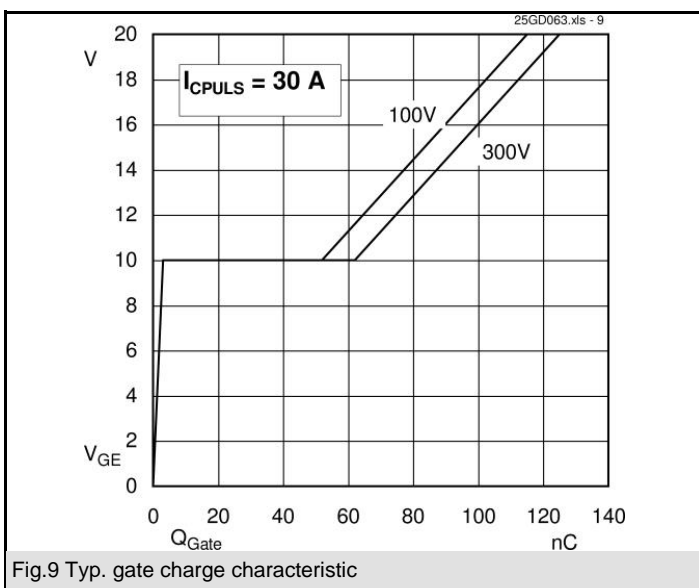
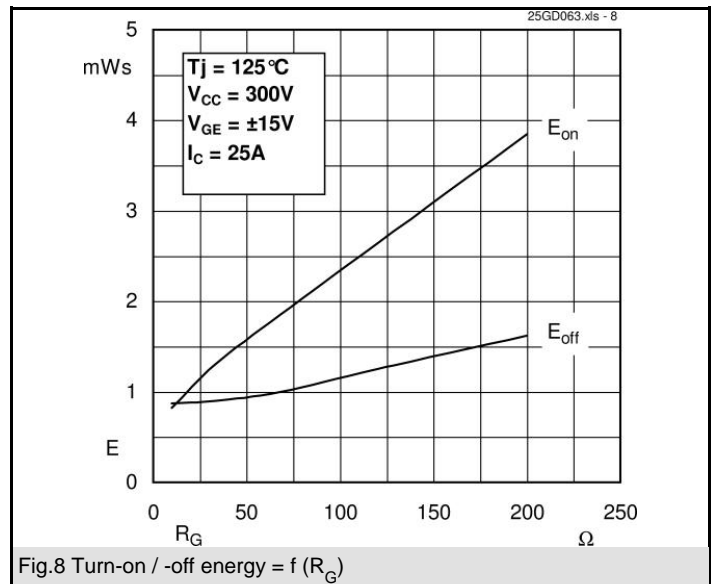
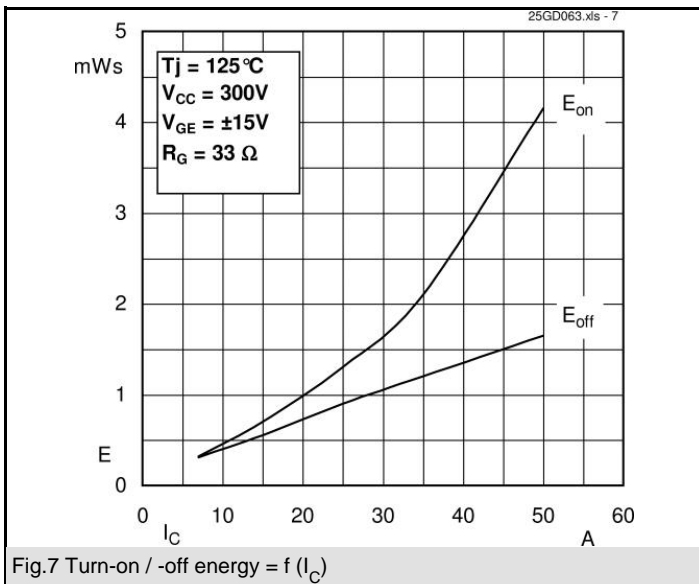
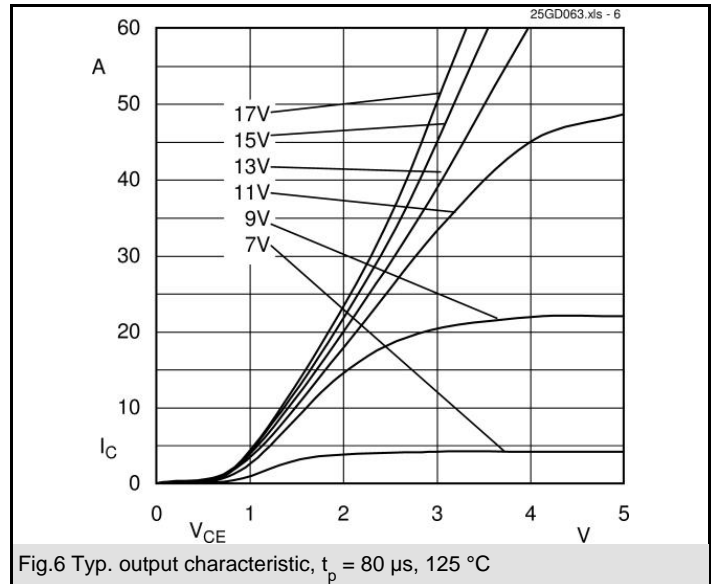
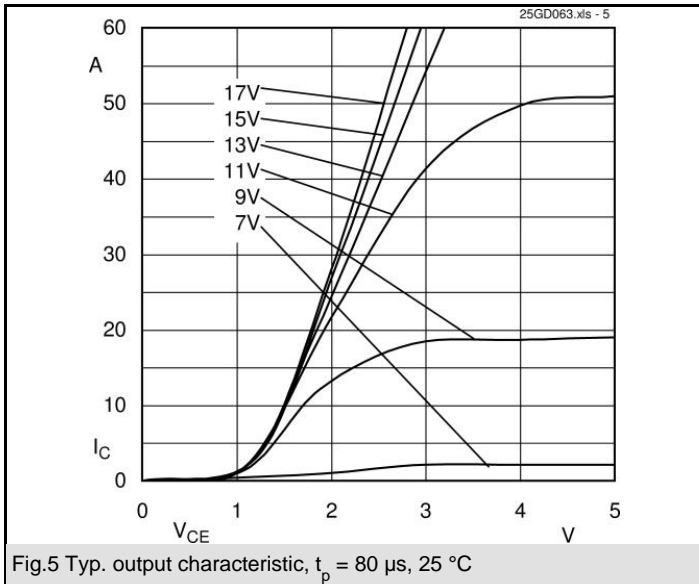

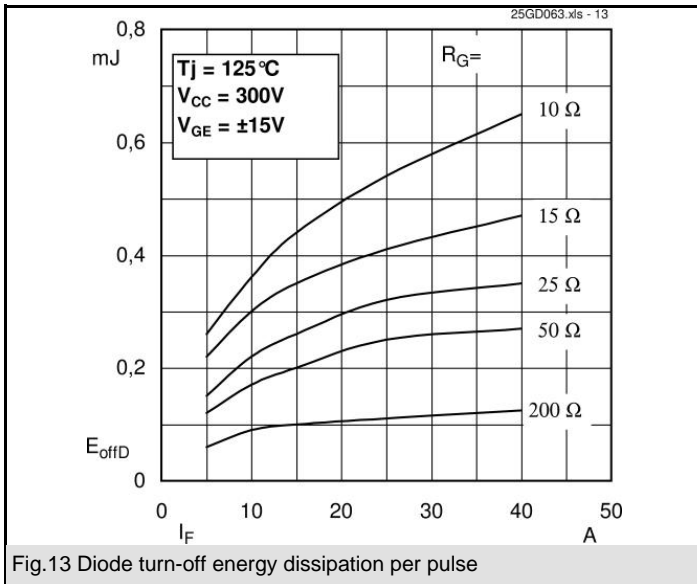
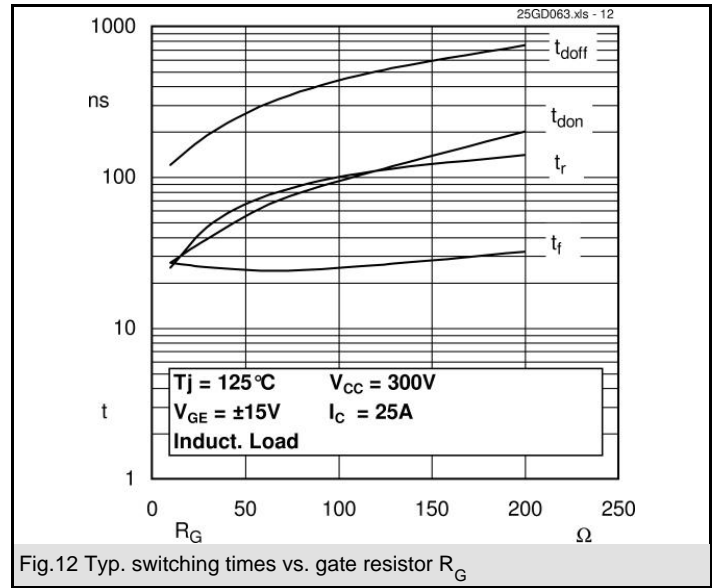
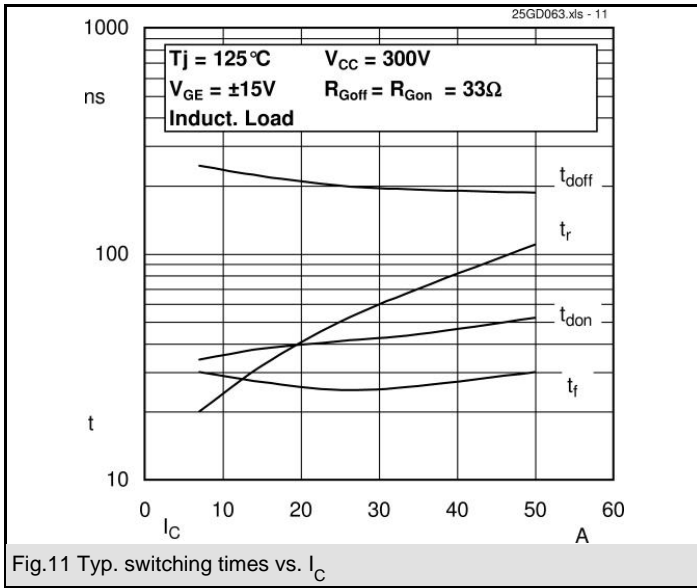

# SK 25 GAD 063 T

UL Recognized  
File no. E 63532

Dimensions in mm

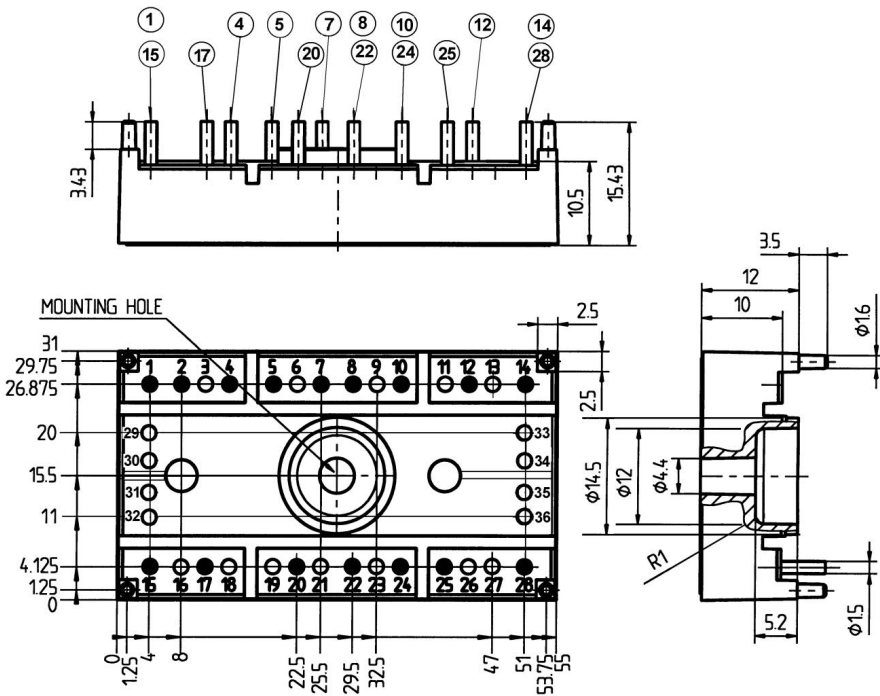

SUGGESTED HOLEDIAMETER FOR THE SOLDER PINS AND THE MOUNTING PINS IN THE  
PCB: 2 mm

Case T 57

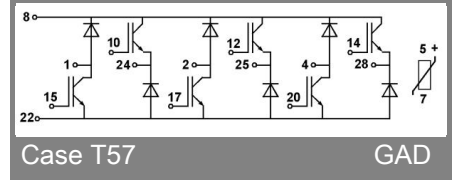

This is an electrostatic discharge sensitive device (ESDS), international standard IEC 60747-1, Chapter IX.

This technical information specifies semiconductor devices but promises no characteristics. No warranty or guarantee expressed or implied is made regarding delivery, performance or suitability.